

Series P000 SOLENOID VALVE

Model#
P02010026E1A

2-Way, Pilot Diaphragm Solenoid Valve
Normally Closed

Technical Specifications

Pipe Size (Inch)	Orifice Size (Inch)	Flow Factor (CV)	
1"	1"	11	
Voltage	Power	Min. Pressure (PSI)	Max Pressure (AC)
120VAC	11.5VA	3	174
Temperature Range	Medium Examples	Sealing Material	
- 22° + 284° F	Light Oils , AirWater	EPDM	

Valve Dimensions

(F.F):	1"
(DN):	1"
(L):	3 11/16"
(L1):	1 15/16"
(L2):	1 11/16 "
(ØA):	2 13/16"
(LF):	11/16"
(H1):	3 3/16"
(H):	4"
(CH):	1 5/8"

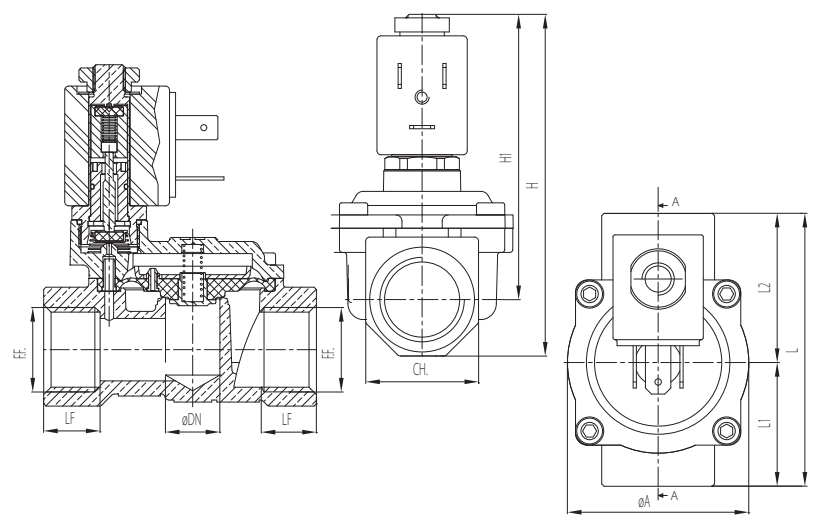

Electrical Connection

Rating:	NEMA 4/ IP 65
Strain Relief Connector:	Model 020

